



## Important Concepts of Grade 5 Mathematics

W1 - Lesson 1 .....	Number Sense Numbers 0 to 100 000
W1 - Lesson 2 .....	Exploring Proper Fractions
W1 - Lesson 3 .....	Exploring Decimals
W1 - Lesson 4 .....	Numbers With Up to 2 Decimal Places
W1 - Lesson 5 .....	Multiplication
W1 - Quiz	
W2 - Lesson 1 .....	Division
W2 - Lesson 2 .....	Collecting Data and Analyzing Patterns
W2 - Lesson 3 .....	Estimating and Taking Measurements
W2 - Lesson 4 .....	Perimeter and Area Measurements
W2 - Lesson 5 .....	Metric Measurements
W2 - Quiz	
W3 - Lesson 1 .....	Volume, Capacity, Mass, and Time
W3 - Lesson 2 .....	2-D Shapes and 3-D Objects
W3 - Lesson 3 .....	Transformations
W3 - Lesson 4 .....	Statistics and Probability
W3 - Lesson 5 .....	Chance and Probability
W3 - Quiz	

## Materials Required

Protractor  
Ruler  
Calculator

A textbook is not  
needed.

This is a stand-alone  
course.

Mathematics Grade 5

Version 5

Preview/Review W3 - Lesson 2 TEACHER KEY

Publisher: Alberta Distance Learning Centre

Author: Leslie Friesen

In-House Teacher: Sue Rees

Project Coordinator: Dennis McCarthy

Preview/Review Publishing Coordinating Team: Nina Johnson,  
Laura Renkema, and Donna Silgard



Alberta Distance Learning Centre has an Internet site that you may find useful. The address is as follows: <http://www.adlc.ca>

The use of the Internet is optional. Exploring the electronic information superhighway can be educational and entertaining. However, be aware that these computer networks are not censored. Students may unintentionally or purposely find articles on the Internet that may be offensive or inappropriate. As well, the sources of information are not always cited and the content may not be accurate. Therefore, students may wish to confirm facts with a second source.

### ALL RIGHTS RESERVED

Copyright © 2007, by Alberta Distance Learning Centre, 4601-63 Avenue, Barrhead, Alberta, Canada, T7N 1P4. Additional copies may be obtained from Alberta Distance Learning Centre.

No part of this courseware may be reproduced or transmitted in any form, electronic or mechanical, including photocopying (unless otherwise indicated), recording, or any information storage and retrieval system, without the written permission of Alberta Distance Learning Centre.

Every effort has been made both to provide proper acknowledgement of the original source and to comply with copyright law. If cases are identified where this effort has been unsuccessful, please notify Alberta Distance Learning Centre so that appropriate corrective action can be taken.

**IT IS STRICTLY PROHIBITED TO COPY ANY PART OF THESE MATERIALS UNDER THE TERMS OF A LICENCE FROM A COLLECTIVE OR A LICENSING BODY.**

# Preview/Review Concepts for Grade Five Mathematics

## *TEACHER KEY*

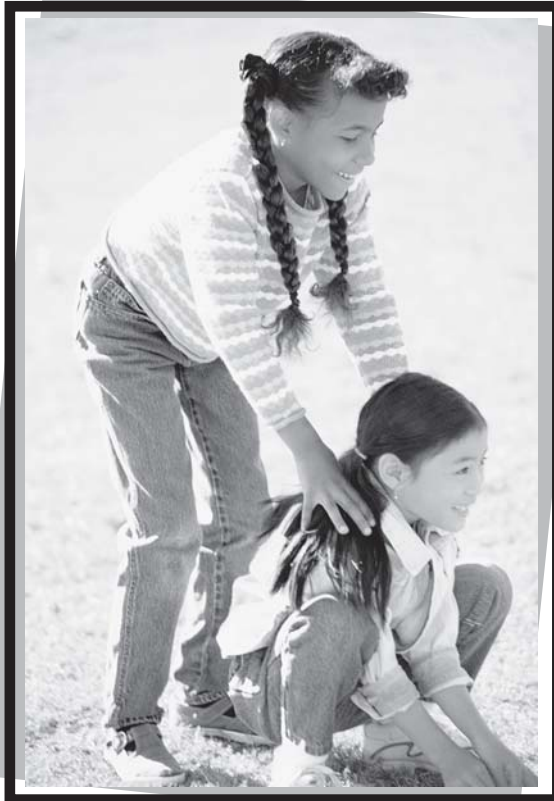

*W3 - Lesson 2:  
2-D Shapes and  
3-D Objects*

# OBJECTIVES

By the end of this lesson, you should

- understand the geometric figures in a *tangram*
- classify triangles
- identify and name polygons
- draw and build 3-D shapes

# Glossary of Terms

**Cube:**  a figure with 6 equal square faces – 3D object (sugar cube)

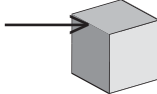
**Edge:**  the line segment where 2 faces of a solid figure meet

**Equilateral triangle:** a triangle that has 3 equal sides



**Face:**  a flat surface in a solid figure

**Hexagon:** a polygon with 6 sides and only 1 line of symmetry

**Isosceles triangle:** a triangle with 2 equal sides



**Kite:** a polygon with 4 sides – 2 pairs of equal adjacent sides

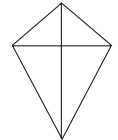

**Octagon:** a polygon with 8 sides

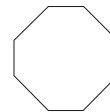

**Parallelogram:** a quadrilateral with 2 sets of parallel sides



**Pentagon:** a polygon with 5 sides



**Polygon:** a closed 2D shape with only straight sides (It can have many sides.)

**Quadrilateral:** a polygon with 4 sides

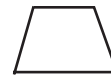

**Rectangle:** a polygon with 4 sides – 2 sets of equal opposite sides meeting at right angles



**Regular Polygon:** a polygon with equal sides and equal angles

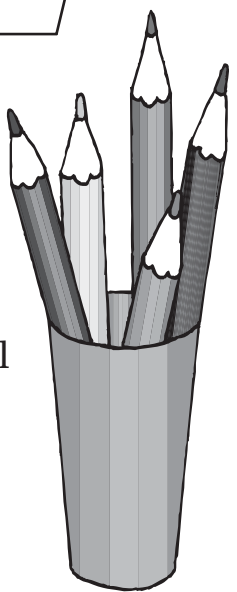



**Right Prism:**

a solid 3D figure in which all the side faces are rectangles

**Rhombus:**

a polygon with 2 sets of all sides are equal length



**Scalene Triangle:**

a triangle that has no equal sides



**Solid Figure:**

a 3D figure with length, width, and depth (such as a pyramid or cube)

**Square:**

a parallelogram with 4 equal sides and right angles

**Tangram:**

a square cut into 7 pieces called tans (the pieces are used to make different shapes as in a Chinese game)

**Trapezium:**

4 -sided polygon with 1 pair of parallel sides; also known as a trapezoid

**Trapezoid:**

a polygon with 4 sides – one pair of parallel sides.

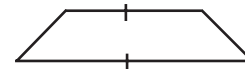

**Triangle:**

a polygon with 3 sides.



**Vertices:**



a point where two or more edges meet (Often the corners – A, B, C – are all vertices where 2 edges meet.)

**3-D Three Dimensional:** measured in 3 directions such as length, width, and height



Cube



Cylinder



Cone



Sphere



Square Prism

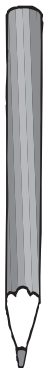
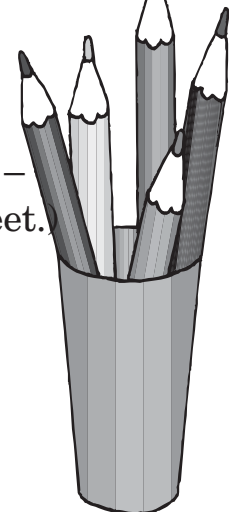

## W3 - Lesson 2: 2-D Shapes and 3-D Objects

### Concepts:

- Tangrams
- Classifying Triangles
- Identify and Name Polygons
- Draw 3-D Shapes
- Build 3-D Shapes

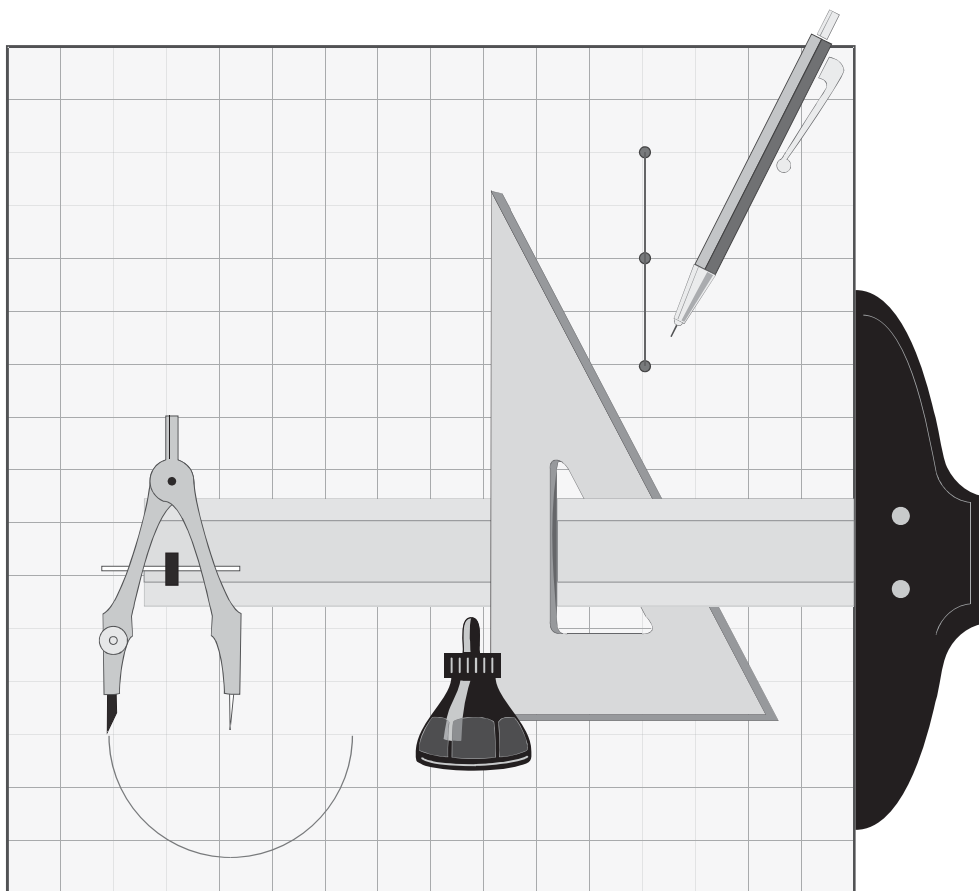

## Tangrams

A **tangram** is a square cut into 7 pieces called tans: 1 parallelogram, 1 square, 1 medium triangle, 2 small triangles, and 2 larger triangles. The pieces are used to make different pictures. (*Tan* means pieces, and *grams* means picture.) Tangrams were invented as a game over 250 years ago by the Chinese.

Using the tangram on the next page of the lesson, try to make the following pictures.

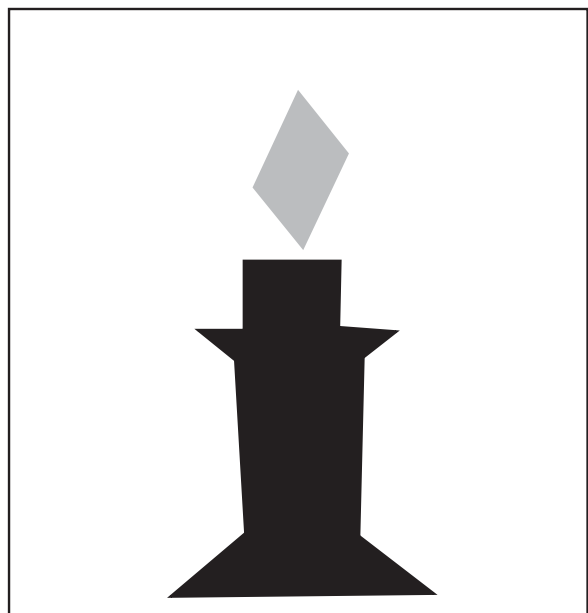
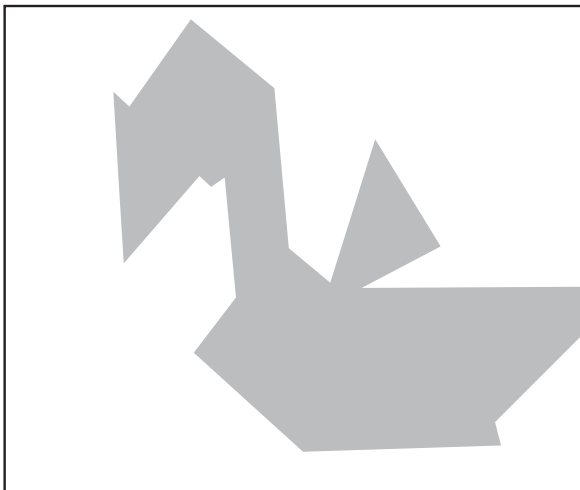
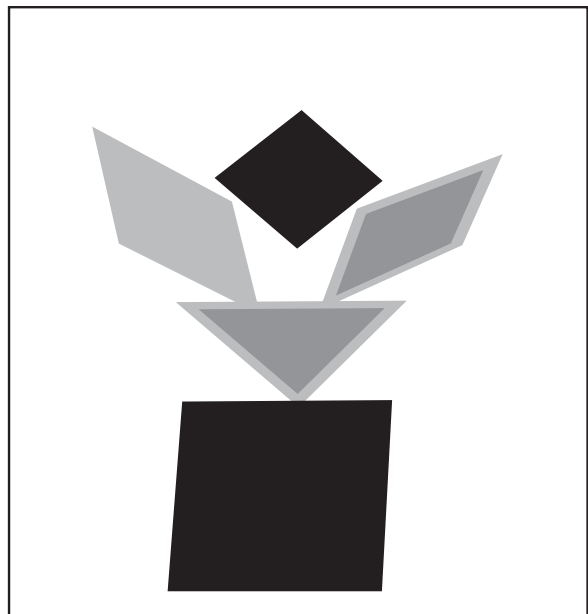
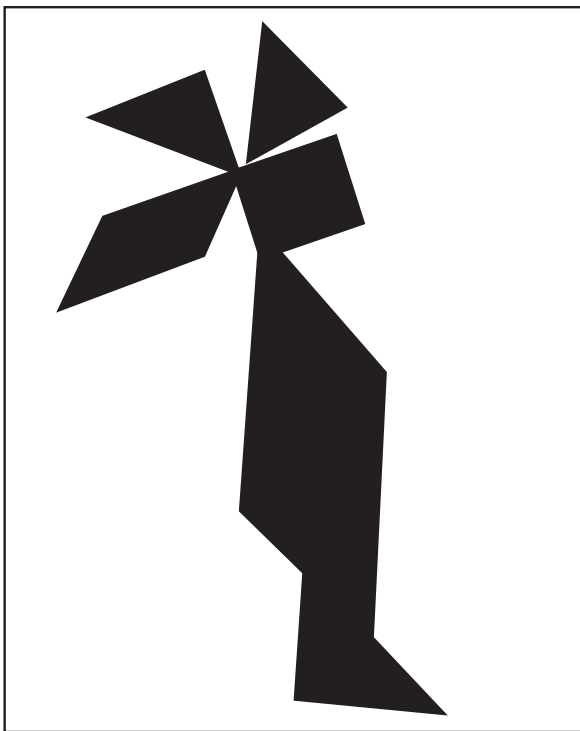



## Tangram Pattern

Cut out these shapes and make the pictures on the previous page. If you have a friend also working on this lesson, make a game of it and see who can create each tangram in the fastest time.

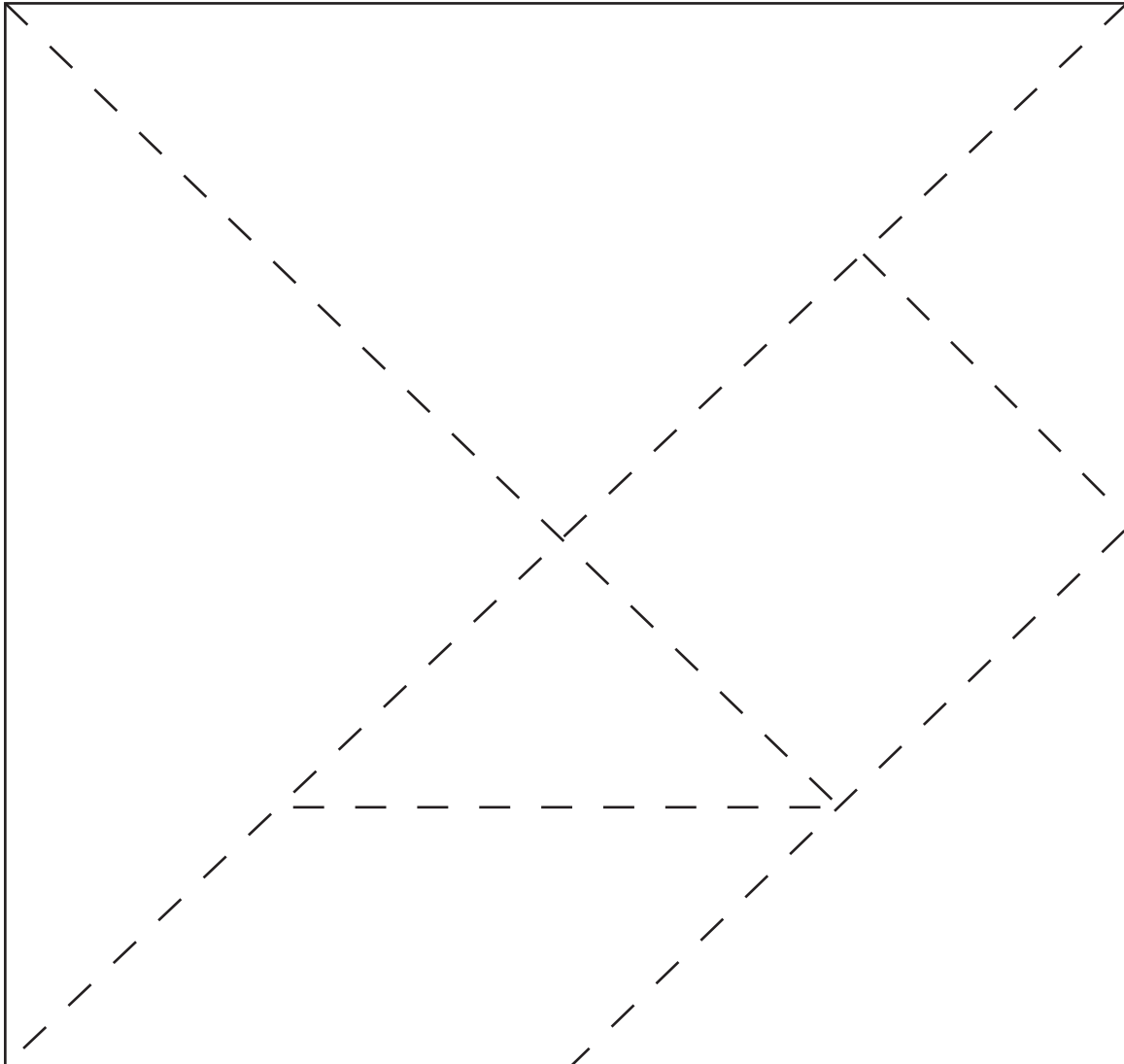



## Classifying Triangles

**Triangle:** a polygon with 3 sides

- **Equilateral triangle:** a triangle with 3 equal sides
- **Isosceles triangle:** a triangle with 2 equal sides
- **Scalene triangle:** a triangle with no equal sides

**Polygon:** a closed 2D shape with only straight sides (It can have three or more sides.)

**Regular polygon:** a polygon with equal sides and equal angles

1. Slashes have been used to show equal sides. What are four ways we can classify this triangle? Choose from the list above.

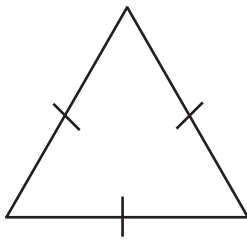

Triangle

Regular polygon

Equilateral triangle

Polygon

2. What are three ways we can classify this triangle?

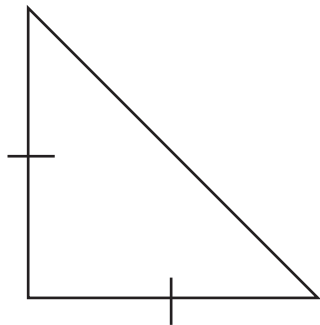

Isosceles triangle

Triangle

Polygon

4. Draw a scalene triangle.

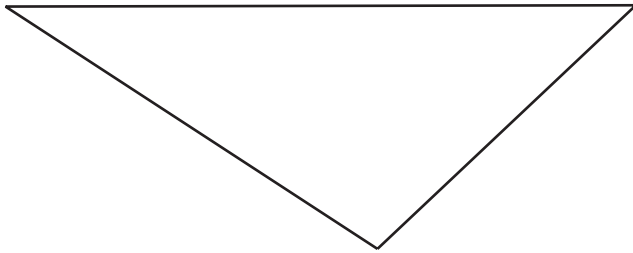

	Number of Equal Sides	Number of Equal Angles
Equilateral triangle	<b>3</b>	<b>3</b>
Isosceles triangle	<b>2</b>	<b>2</b>
Scalene triangle	0	0

### Identify and Name Polygons

Polygons are two-dimensional shapes with straight sides. The prefix of each polygon tells how many sides the shape has. Keep in mind that some polygons can have several looks. For example, a square can become a rhombus if the angles are changed.

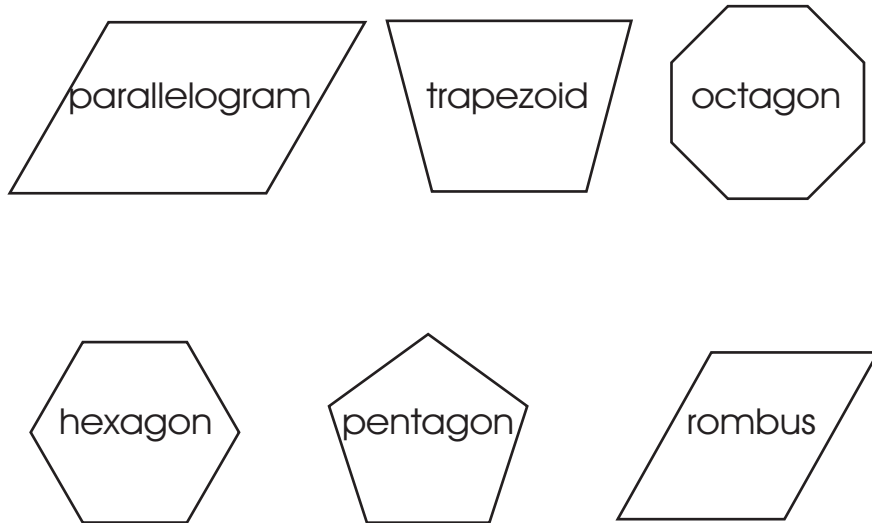

Use the glossary to help you fill in the chart below.

	<b>Number of Sides</b>	<b>Are all the Sides the Same Length</b>	<b>Number of Angles</b>	<b>Number of Vertices</b>
triangle	<b>3</b>	<b>No</b>	<b>3</b>	<b>3</b>
quadrilateral	<b>4</b>	<b>No</b>	<b>4</b>	<b>4</b>
pentagon	<b>5</b>	<b>No</b>	<b>5</b>	<b>5</b>
hexagon	<b>6</b>	<b>No</b>	<b>6</b>	<b>6</b>
octagon	<b>8</b>	<b>No</b>	<b>8</b>	<b>8</b>
kite	<b>4</b>	<b>No</b>	<b>4</b>	<b>4</b>
parallelogram	<b>4</b>	<b>No</b>	<b>4</b>	<b>4</b>
rectangle	<b>4</b>	<b>No</b>	<b>4</b>	<b>4</b>
rhombus	<b>4</b>	<b>YES</b>	<b>4</b>	<b>4</b>
square	<b>4</b>	<b>YES</b>	<b>4</b>	<b>4</b>
Trapezium	<b>4</b>	<b>No</b>	<b>4</b>	<b>4</b>
Trapezoid	<b>4</b>	<b>No</b>	<b>4</b>	<b>4</b>

### Draw 3-D Shapes

Drawing 3-D shapes is easier with graph or dot paper. Copy the shapes below exactly. Then try enlarging or reducing a favourite shape. Try a different 3-D shape.

*Answers as shown*

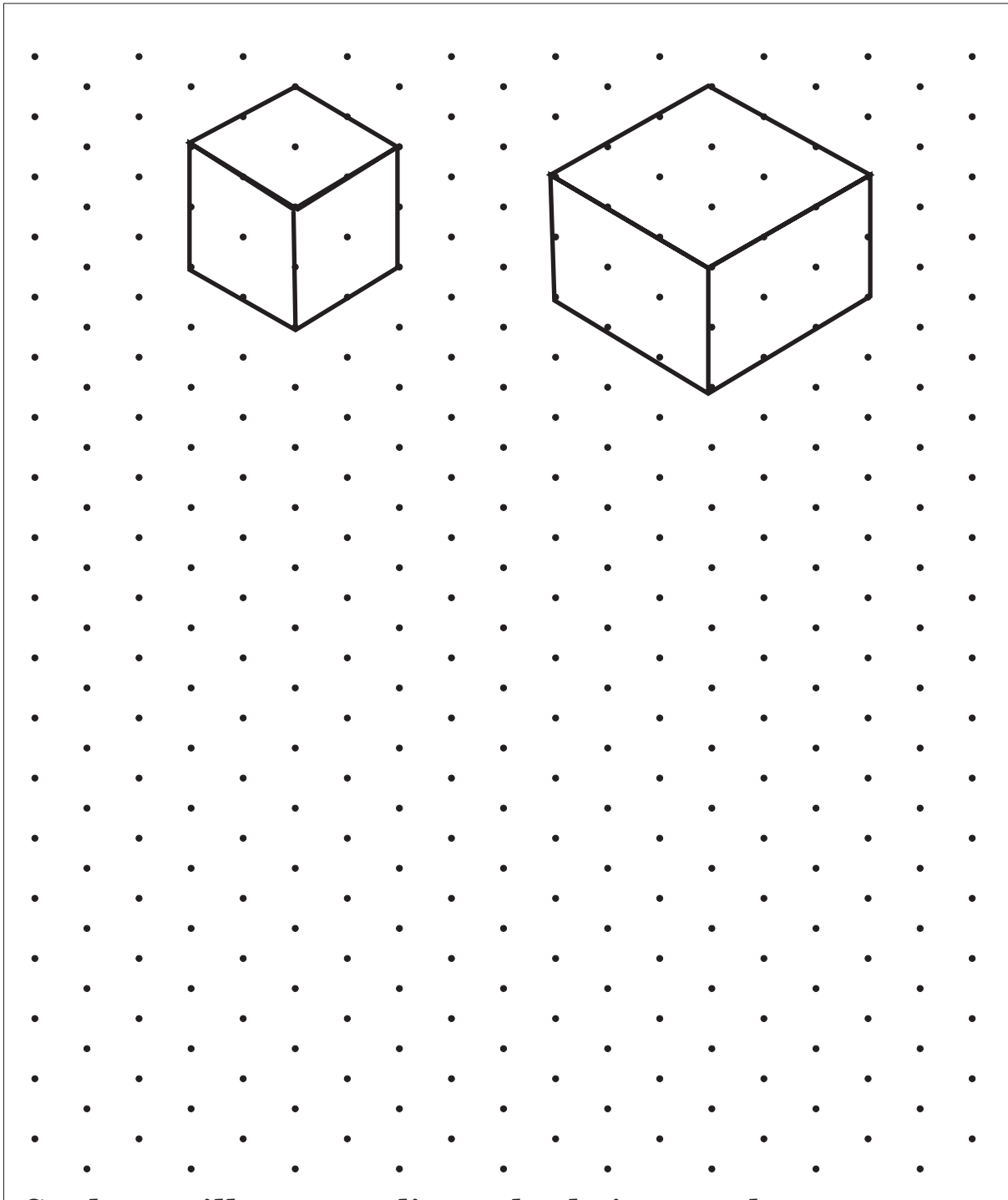

*Students will try to replicate the designs or shapes.*

### Build 3-D Shapes

Complete the questions below.

Label this cube with the appropriate terms listed along the side. Draw an arrow to the correct part of the cube.

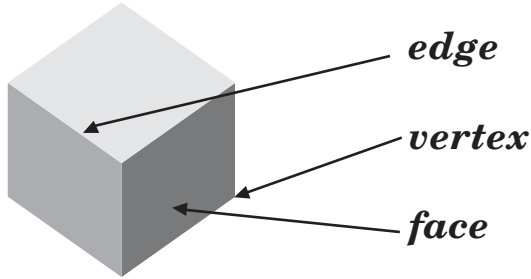

Give 5 examples of sphere-shaped items. (*Various answers*)

- baseball
- earth or sun
- orange or soccer ball
- bath balls
- planets

Name the one common solid shape for these items.

Pop can	<b><i>cylinder</i></b>
Container of Pringles chips	
A section of pipe	
A funnel	
Prism	

Draw a triangular pyramid.

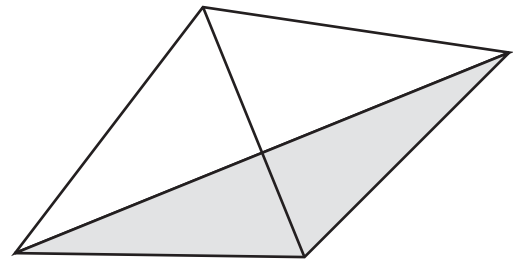

**On a cylinder,**

- How many vertices? 0
- How many edges? 2
- How many faces? 3
- How many curved edges? 2
- How many curved surfaces? 1

**On a triangular prism,**

- How many vertices? 6
- How many edges? 9
- How many faces? 5
- How many curved edges? 0
- How many curved surfaces? 0





### Build 3D Shapes-Patterns

Please note: some pieces overlap.  
Cut out the two shapes below to build 3-D objects.

